

5951
Military Chopper

**MEGA
BLOKS**

nanoTM
Building System



7+ Ages / Edades
Ages / Leeftijden

150 Pieces / Piezas
Pièces / Stuks



Welcome to the world of NANO!

NANO Bloks™ is an exciting, new, miniature construction system, which allows you to BUILD, PLAY and COLLECT in a size and range that you have never seen before. I am NANOMAN and let me introduce you to a cool new world of building detail, action and fun!

¡Bienvenido al mundo de NANO!

NANO Bloks™ es un nuevo y excitante sistema de construcción miniatura que te deja CONSTRUIR, JUGAR y COLECCIONAR en una dimensión y de alcance nunca visto antes. ¡Soy NANOMAN, permítame que te presente un asombroso nuevo mundo para construir con detalles, acción y entretenimiento!



Bienvenue au monde de NANO!

NANO Bloks™ est un nouveau et fascinant système de construction à partir de pièces miniatures qui vous permet de CONSTRUIRE, de JOUER et de COLLECTIONNER un éventail de pièces d'une taille inédite. Je suis NANOMAN. Permettez-moi de vous présenter un nouveau monde de construction, d'action et de plaisir !

Welkom in de wereld van NANO!

NANO Bloks™ vormt een nieuw en opwindend miniatuur bouwsysteem dat je laat BOUWEN, SPELEN en VERZAMELEN in een formaat en verscheidenheid dat je nooit eerder gezien hebt. Ik ben NANOMAN en ik wil je bekend maken met een leuke nieuwe wereld van bouwdetails, actie en plezier.

I am here to help you with your building project so look for me throughout this playbook. I will guide you through the more challenging sections of these instructions to make sure that your building experience is easy, fun & rewarding.

Aquí estoy para ayudarte con tu proyecto de construcción, así que búscame en todo este libro de juego. Seré tu guía a través de las secciones más complejas de estas instrucciones para que tu aventura de constructor resulte fácil, entretenida y gozosa.

Je suis ici pour vous aider dans votre projet de construction. Il suffit de me rechercher dans ce livre de jeu. Je vous accompagnerai à travers les sections les plus difficiles de ces instructions pour vous assurer une expérience de construction facile, amusante et valorisante.

Ik ben hier om je te helpen met je bouwproject, dus je vindt me overal in deze handleiding. Ik zal je gids zijn in de meer ingewikkelde delen van deze instructies om jouw bouwervaring zo gemakkelijk, plezierig en bevredigend te maken als het maar kan.

Please read these instructions carefully before first use and keep them for future reference.

Leer estas instrucciones cuidadosamente antes de la primera utilización y guárdarlas para referencia futura.

Il est recommandé de lire attentivement ce feuillet avant la première utilisation et de le conserver pour référence future.

Wij raden u aan deze handleiding zorgvuldig te lezen en te bewaren voor eventuele raadpleging op een later tijdstip.

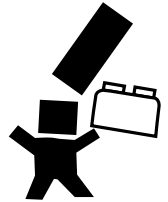

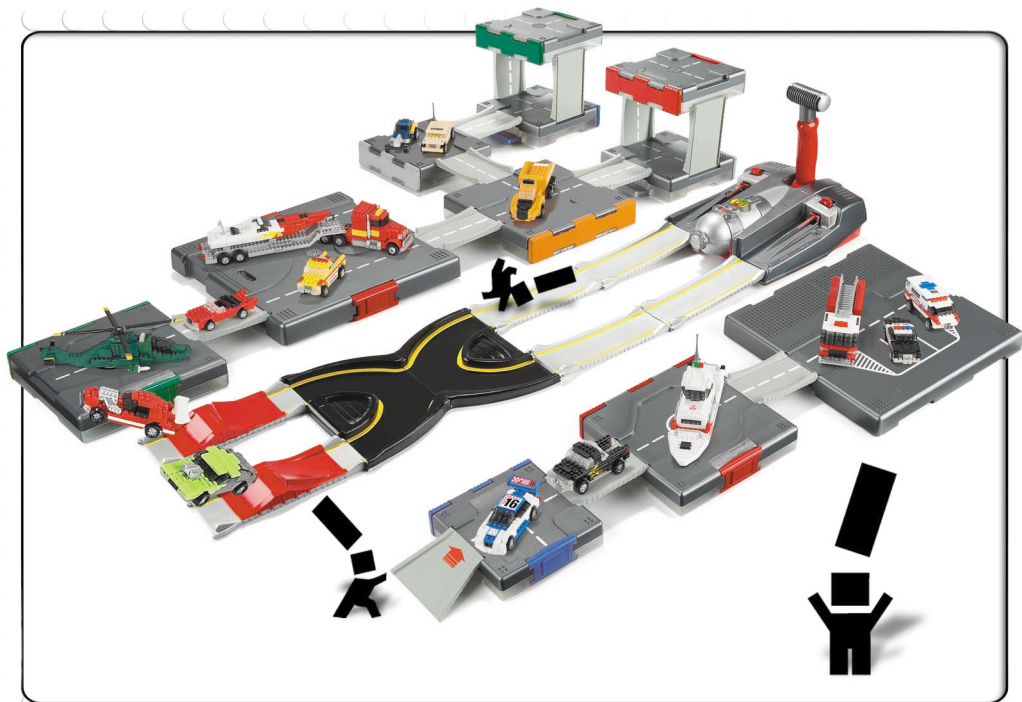

Military
Militar
Militaires
Militair

Racing
Carreras
Course
Racing

Rescue
Rescate
Secours
Redding

Construction
Construcción
Construction
Gebouw

Classic/Show cars
Autos clásicos/exhibición
Voitures classiques/d'exposition
Klassieke/Show autos

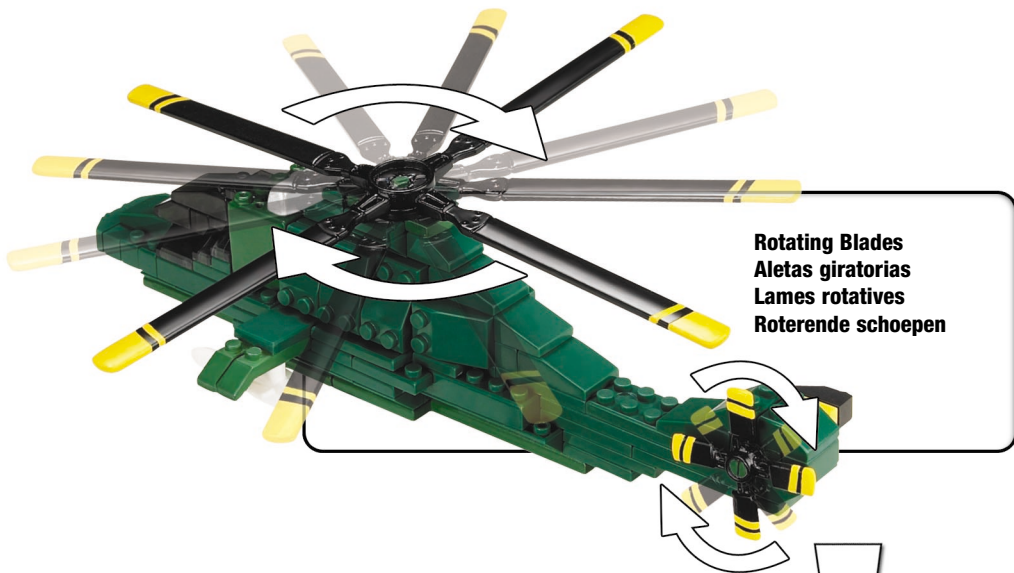

Rotating Blades
Aletas giratorias
Lames rotatives
Roterende schoepen

Press this button to activate vehicle sound

**Apretar este botón para activar el
sonido del vehículo**

**Appuyer sur ce bouton pour activer
les sons du véhicule**

**Druk op deze knop om het geluid van
het voertuig in werking te stellen**

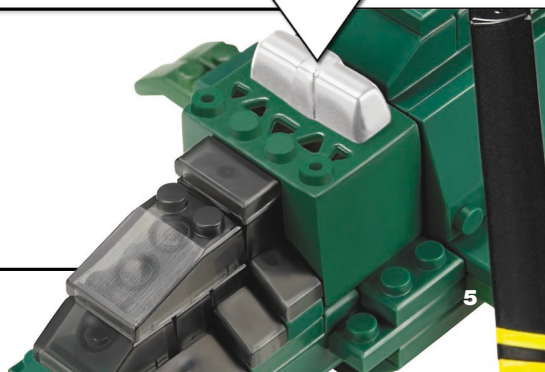

**Nanocase Building / Construcción Nanocase
Construction Nanocase / Nanocase Gebouw**

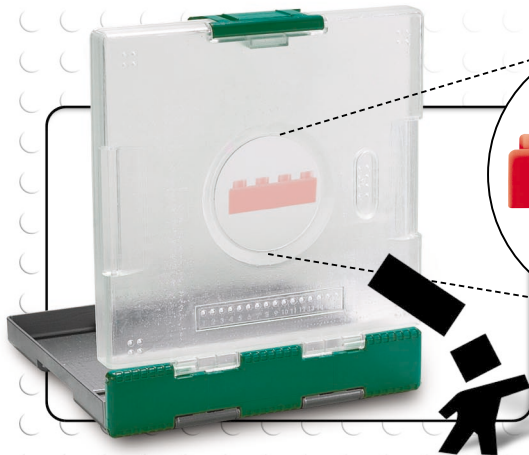

**Nano-magnifier
Nano-lupa
Nano-loupe
Nano-loep**



**Ruler to measure Nano Bloks™ pieces.
Regla para medir piezas Nano Bloks™.
Règle pour mesurer les pièces
Nano Bloks™.
Lineaal voor het meten van Nano
Bloks™ bouwstenen.**

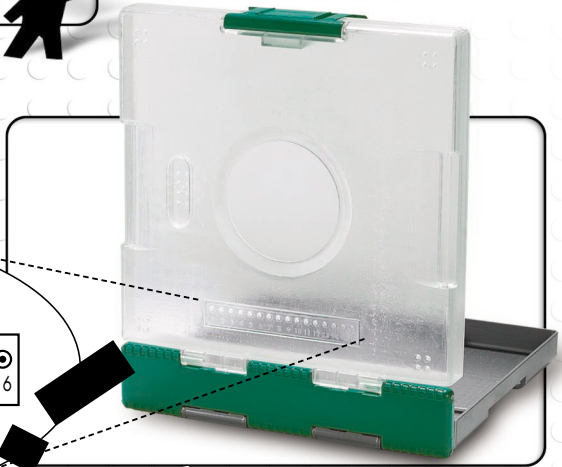

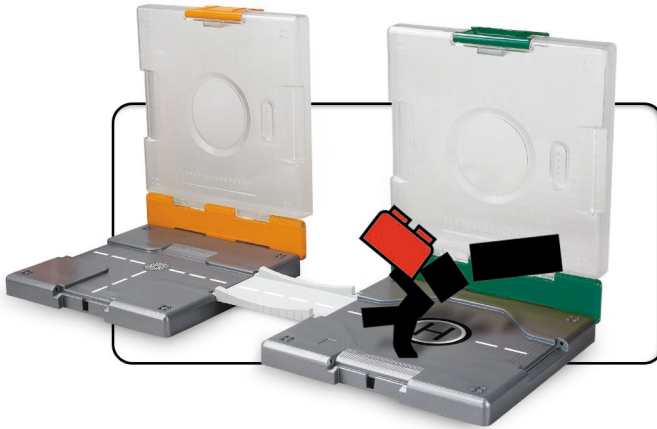

**Collect 'n Connect
Road System**
**Sistema vial colector
/conectar**
**Système de chemins à
collectionner et à relier**
**Verzamel-en-Verbind
wegennet**

Detailed Environments
Paisajes detallados
Environnements détaillés
Gedetailleerde milieus



**Nanocase Display / Presentación Nanocase
Présentoir Nanocase / Nanocase Uitstalling**

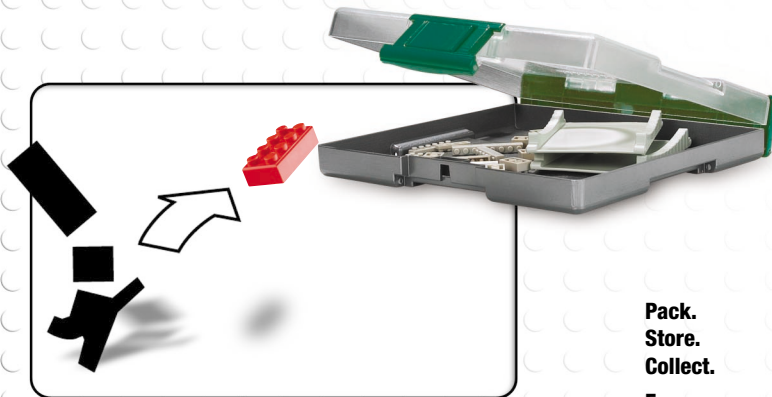

**Pack.
Store.
Collect.**

**Empaca.
Almacena.
Colecciona.**

**Ranger.
Collectionner.**

**Verpak.
Bewaar.
Verzamel.**



Military Chopper

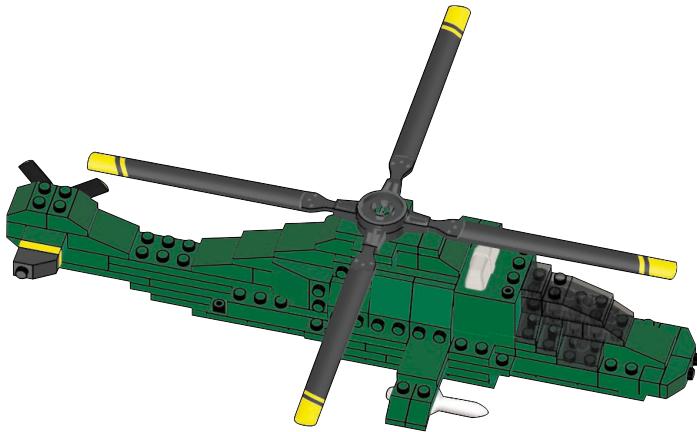







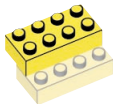



















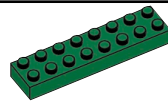







Color chart • Cuadro cromático Charte de couleurs • Färgtabell

Active step
Etapă activă
Étape active
Aktivt skede



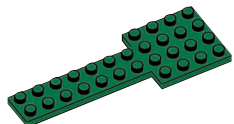

Previous step
Etapă precedentă
Étape précédente
Föregående skedet

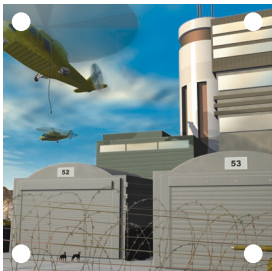
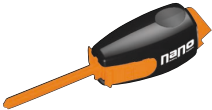
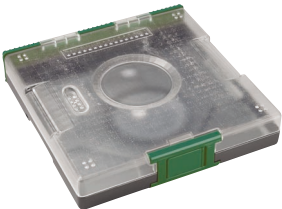

Parts List • Lista de piezas Liste de pièces • Onderdelenlijst

	2x AM25008JM		1x AM25047JM		1x AM25043JM		2x AM25015JM		2x AM25089E	
	7x AM25009JM		17x AM25047DO		1x AM25040JM		4x AM25035JM		4x AM25016JM	
	2x AM25009WA		2x AM25048JM			2x AM25005JM		7x AM25017JM		
	5x AM25033JM		1x AM25021JM			4x AM25045JM			1x AM25023JM	
	1x AM25033WA		6x AM25027JM			2x AM25006JM				
	2x AM25003JM		3x AM25027WA			1x AM25018JM		2x AM25053JM		
	1x AM25003WA		23x AM25031JM							
	1x AM25003JN		8x AM25004JM							
	2x AM25025JM		11x AM25028JM					2x AM25072JM		
	1x AM25025F		1x AM25028WA							
	4x AM25025WA		2x AM25007JM							

Parts List • Lista de piezas Liste de pièces • Onderdelenlijst

		<p>1x AD059511</p>		<p>1x AS059013</p>
<p>1x AS059516</p>		<p>1x AS059511</p>		<p>2x AS059015</p>
				
<p>4x AM25034MM</p>				<p>2x AS059515</p>
				
<p>1x AS059513</p>				

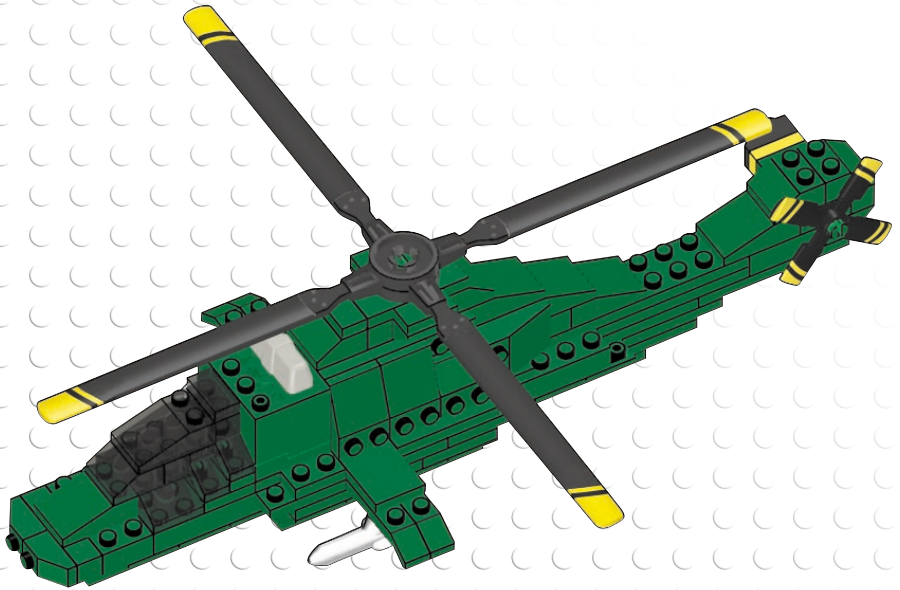

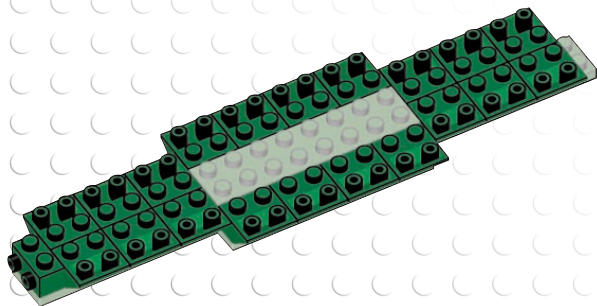

02



20x



1x

03

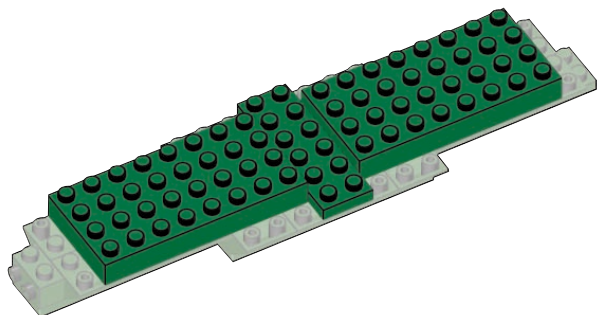
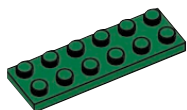
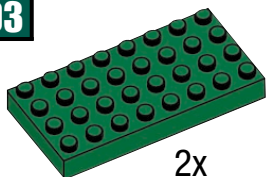

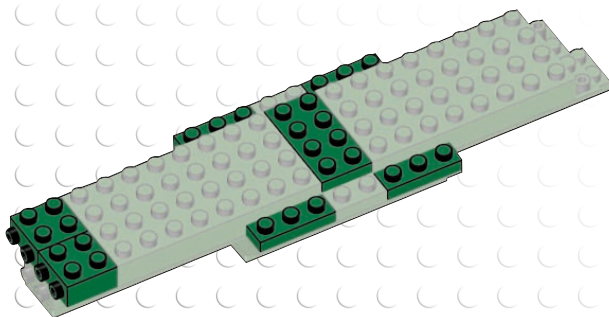

04



2x



4x



1x

05



4x



2x



1x



2x

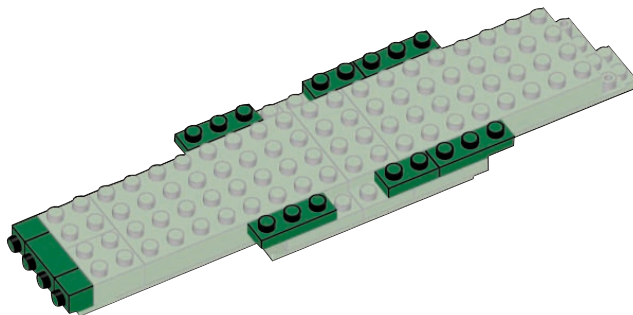

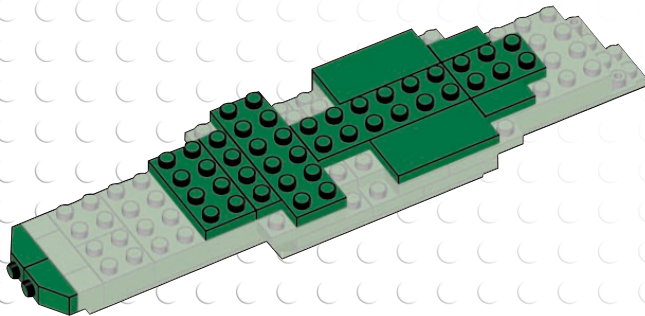

06

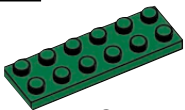

2x



1x



2x



1x



1x



2x



2x

07

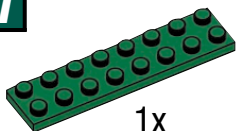

1x

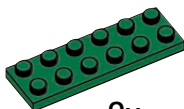

2x



2x



1x



1x



1x



2x



1x



1x



1x



1x

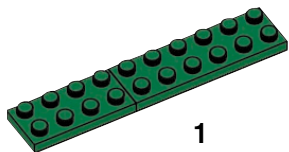

1

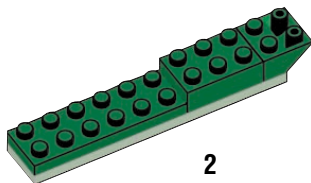

2

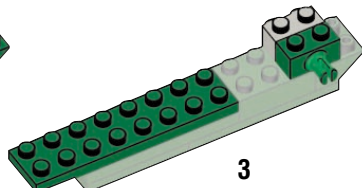

3

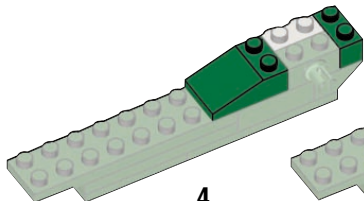

4

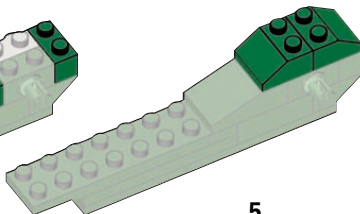

5

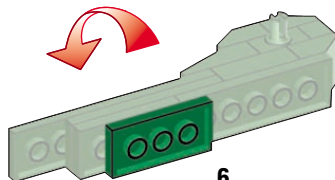

6

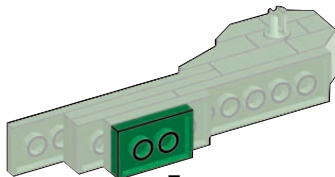

7

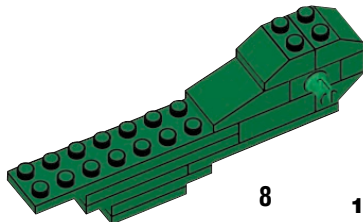

8

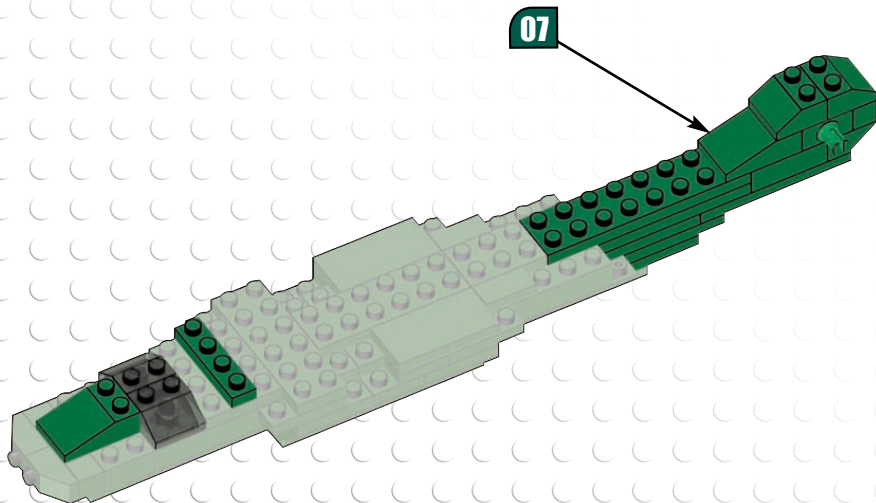

08



1x



2x



1x

09



1x



2x



1x



1



2



3

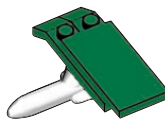

4



1



2



3



4

10



1x



2x



1x

11



1x



1x



1x



6x



4x

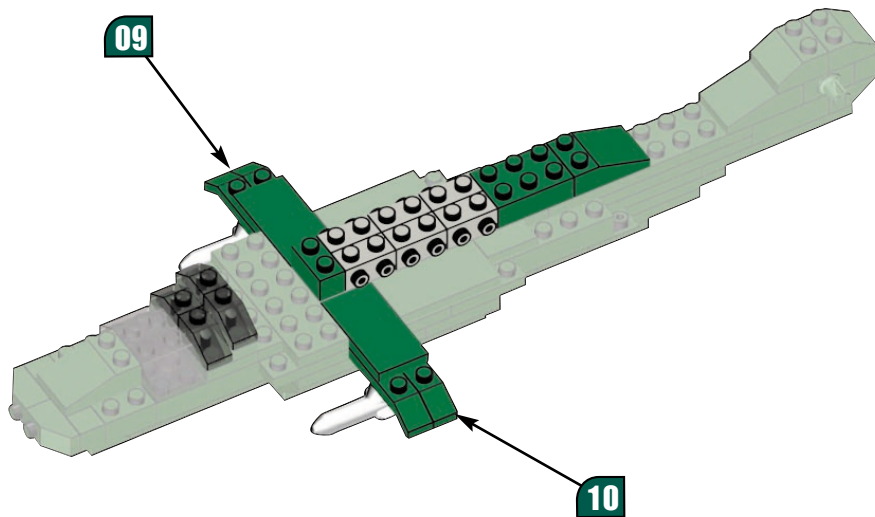

09

10

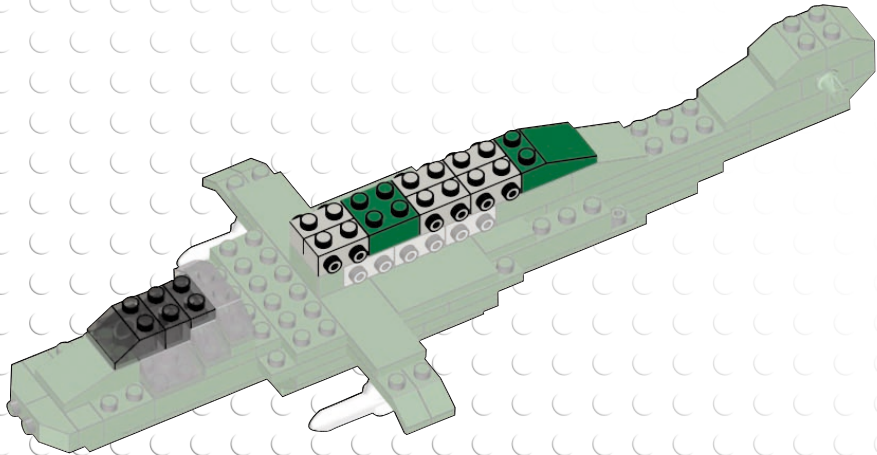

12



1x



1x



1x



6x



1x



1x

13

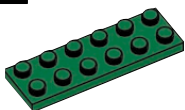

2x



2x

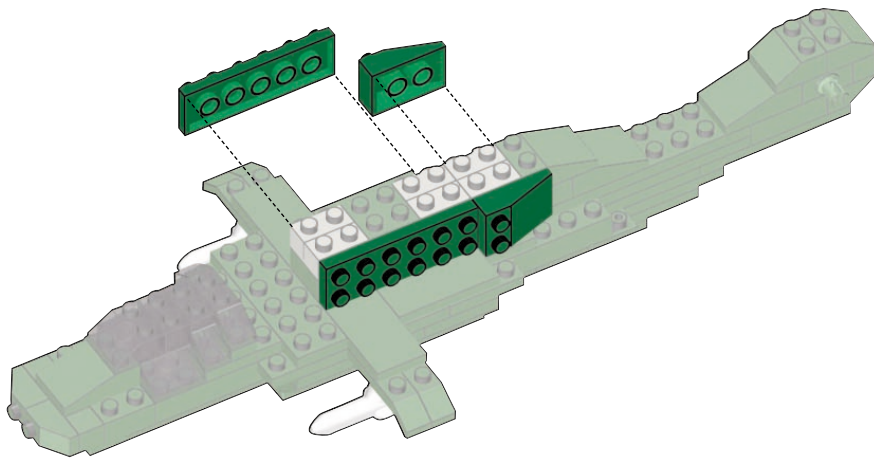

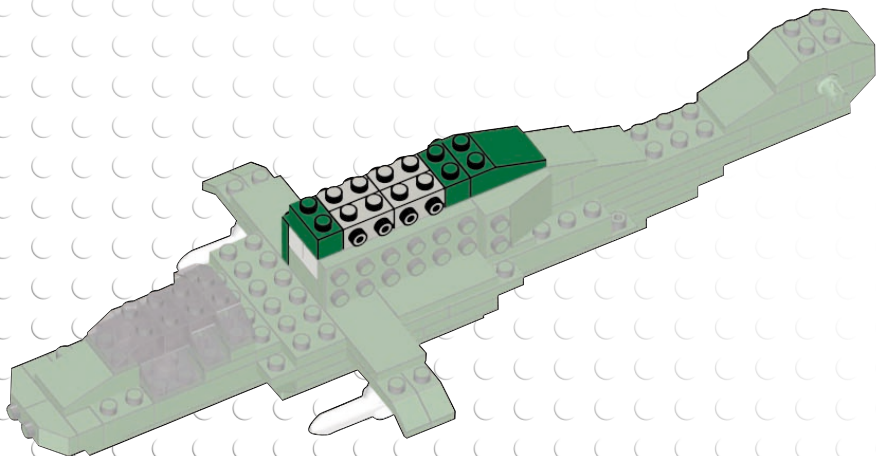



14



1x



4x



2x

15



2x

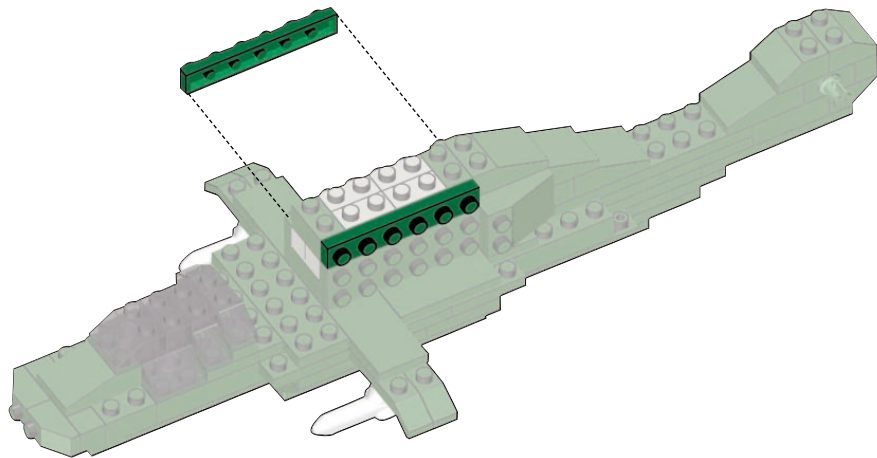

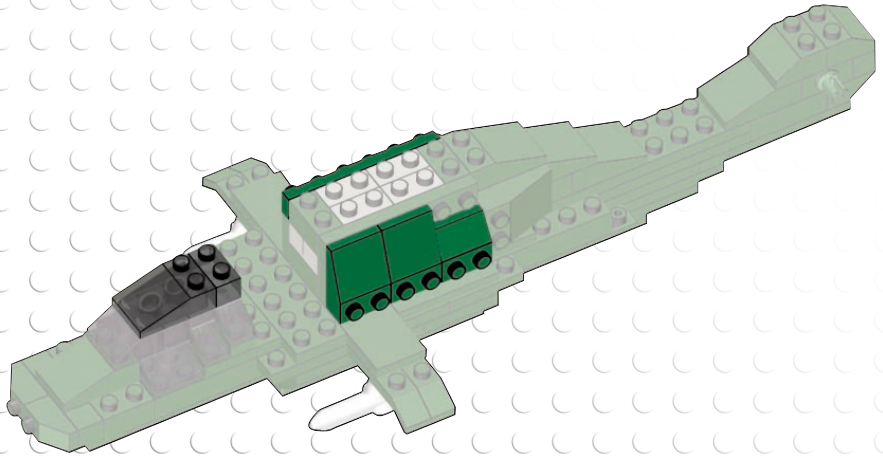

16



2x



1x



1x



1x

17



2x



1x



1x



1x



1x



1x

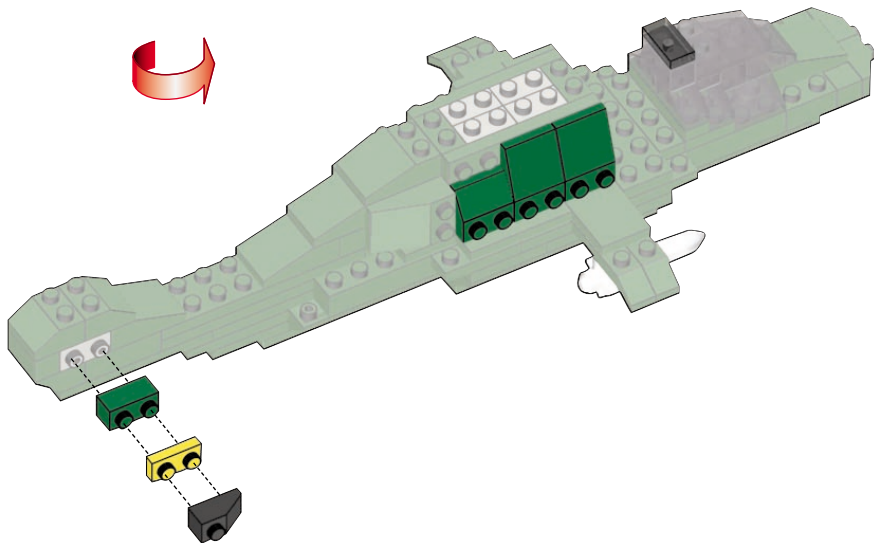

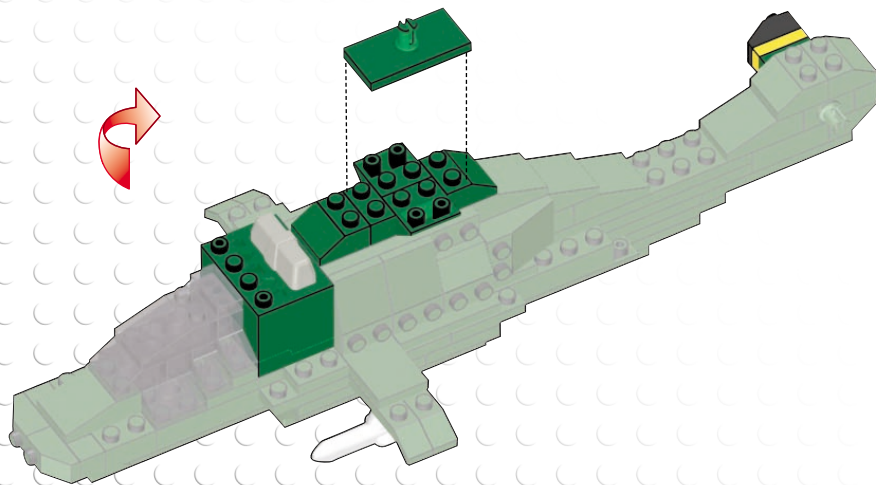

18



2x



2x



1x

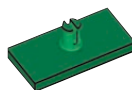

1x

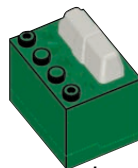

1x

19



3x

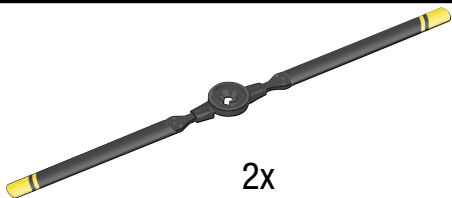

2x



1x

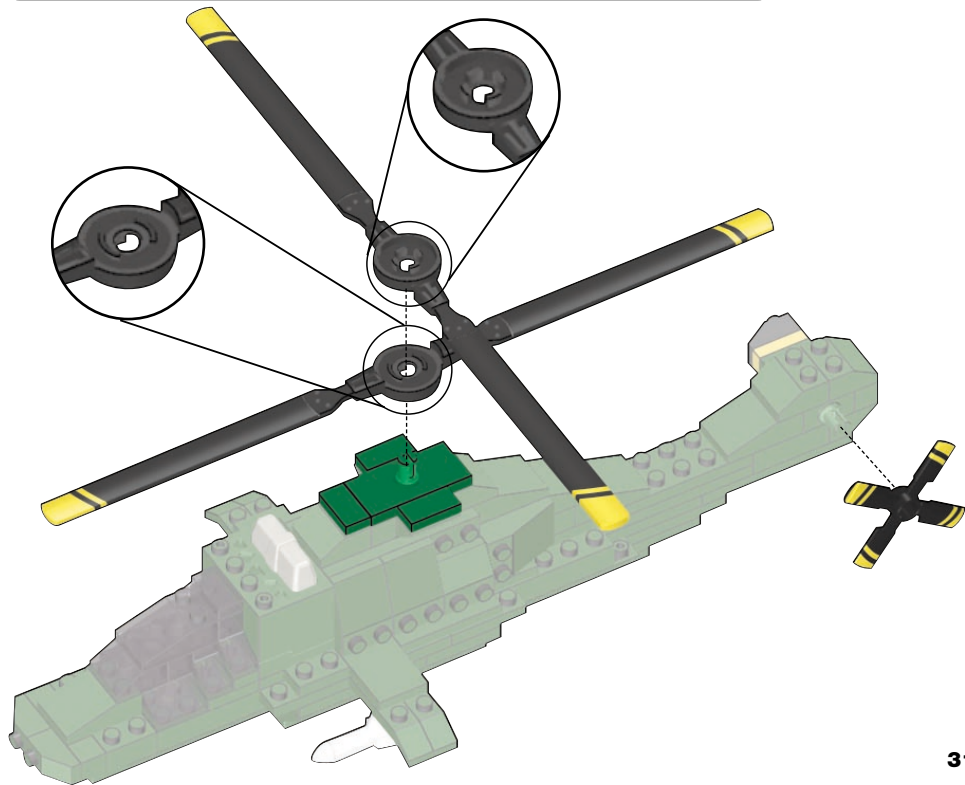

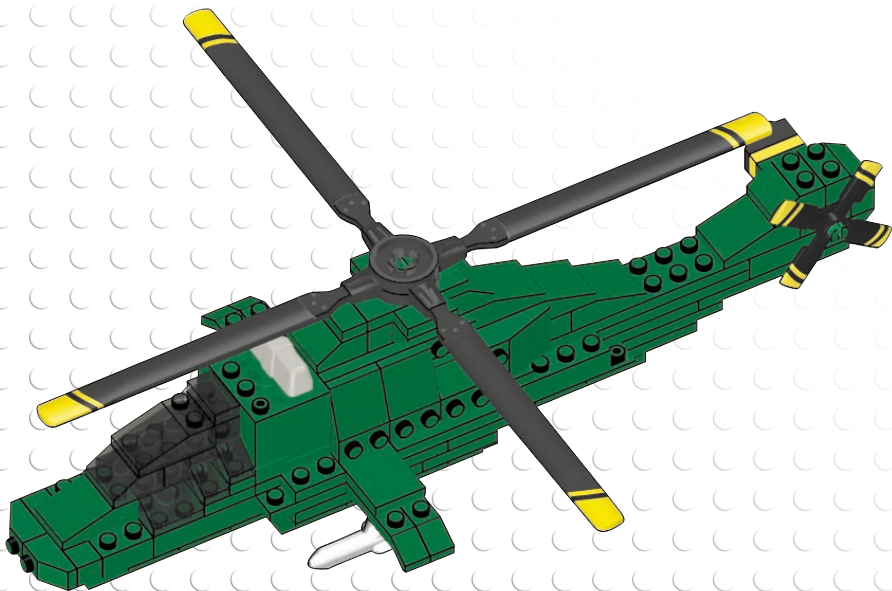

20

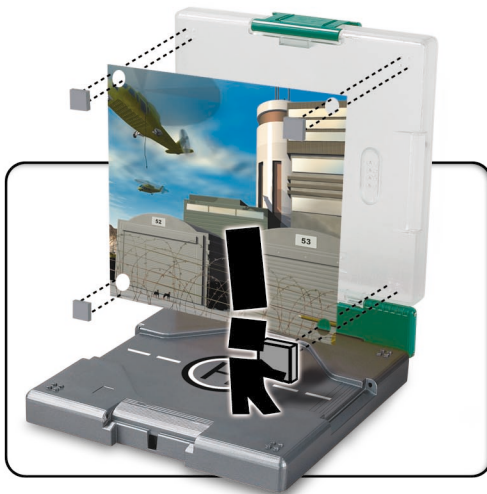
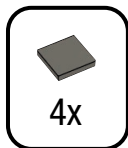



Connect
Empalmar
Relier
Verbinden

Additional purchases
 required to collect
 all elements shown.

Para coleccionar todos los
 elementos mostrados
 se precisa realizar unas
 compras adicionales.

Des achats additionnels
 sont nécessaires afin
 d'obtenir tous les articles
 de la collection illustrés.

Verdere aankopen zijn
 nodig om alle afgebeelde
 artikelen te verzamelen.

Stack & Display
Apilar & Presenta
Empiler et
présenter
Stapelen en
Uitstallen



Canyon Cruiser™



5901

Turbo Rally Racer™



5902

Police Interceptor™



5903

Rebel Roadster™



5904

Off Road Runner™



5905

Sand Storm™



5906

Nano Speed Launcher
Lanzador Relámpago Nano
Lanceur rapide Nano
Nano snellanceerinstallatie

Military Chopper

5951



**Sound / Sonido
Son / Geluid**

Rescue Cutter™

5952



Construction Hauler

5954



5981

Emergency Response™



Lights and sound
Luces y sonido
Son et lumière
Licht en geluid

5983

Off Shore Racing™



Nanoverse

5990

Power up launcher
Arranca la lanzadora
Activer le lanceur
Breng de lanceerinrichting op kracht

Stunt ramps
Rampas acrobáticas
Rampes à cascades
Stuntopritten

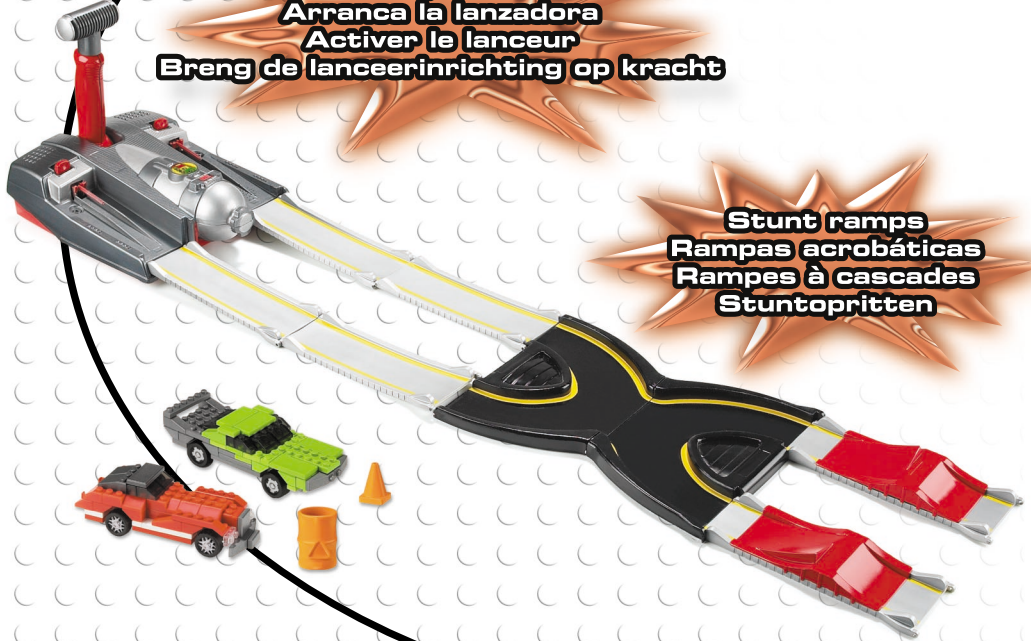

Smokin' Stunt Speedway™

Also Available
También disponible
Également disponible
Eveneens beschikbaar



TM & © BVS.



©2003 Mirage Studios, Inc. Teenage Mutant Ninja Turtles™ is a trademark of Mirage Studios, Inc. All rights reserved.
©2003 Mirage Studios, Inc. Teenage Mutant Ninja Turtles™ es marca registrada de Mirage Studios, Inc. Todos los derechos reservados.
©2003 Mirage Studios, Inc. Teenage Mutant Ninja Turtles™ est une marque de commerce de Mirage Studios, Inc. Tous droits réservés.
©2003 Mirage Studios, Inc. Teenage Mutant Ninja Turtles™ is een handelsmerk van Mirage Studios, Inc. Alle rechten voorbehouden.

➤ BATTERY INSTALLATION

- Use a Phillips (star-bit) screwdriver to unscrew the door of the battery compartment.
- Lift and remove the compartment door.
- Insert the 1.5 volt batteries according to the correct polarity shown.
- Replace the door and the screws, do not over-tighten the screws.

➤ INSTALACIÓN DE LAS PILAS

- Utilizar un destornillador en cruz (o con punta de estrella) para abrir la tapa del compartimiento de las pilas.
- Levantar y retirar la tapa del compartimiento de las pilas.
- Introducir las pilas de 1.5 voltios según la polaridad indicada.
- Reponer la puerta y los tornillos, evitando apretarlos demasiado.

➤ CAUTION: TO AVOID BATTERY LEAKAGE:

1. See the diagram to know how to remove and insert batteries.
2. Non-rechargeable batteries must never be recharged.
3. Rechargeable batteries must be removed from toy before being recharged and rechargeable batteries should be charged under adult supervision.
4. Do not mix alkaline, standard (carbon zinc), or rechargeable (nickel cadmium) batteries. Do not mix used and new batteries together.
5. Only batteries of the recommended type or of a similar type should be used.
6. Batteries must be inserted according to the correct polarity. (see diagram)
7. Remove batteries immediately after an extended period of time or if batteries are exhausted.
8. The supply terminals must not be short-circuited.

➤ ADVERTENCIA: PARA EVITAR QUE LAS PILAS SE SULFATEN:

1. Consultar el diagrama para saber cómo retirar e introducir las pilas.
2. No recargar jamás pilas que no sean recargables.
3. Retirar las pilas recargables del juguete antes de recargarlo; las pilas recargables deben cargarse bajo la supervisión de un adulto.
4. No mezclar pilas alcalinas, con pilas standard (carbon zinc) ni lampoco con pilas recargables (níquel cadmio). No mezclar pilas usadas con pilas nuevas.
5. Solamente deben utilizarse las pilas del tipo recomendado o de tipo similar.
6. Colocar las pilas respetando la polaridad correcta. (ver diagrama)
7. Retirar las pilas del juguete cuando vaya a guardarlo durante un periodo largo de tiempo o si las pilas están gastadas.
8. No originar cortocircuitos en los bornes del compartimiento de las pilas.

➤ AVERTISSEMENT: POUR ÉVITER LA FUITE DES PILES:

1. Consulter le diagramme pour savoir comment enlever ou mettre en place les piles ou les accumulateurs.
2. Ne jamais recharger des piles (non-rechargeables).
3. Les accumulateurs doivent être enlevés du jouet avant d'être chargés et les accumulateurs ne doivent être chargés que sous la surveillance d'un adulte.
4. Différents types de piles alcalines, standard (carbure zinc) ou d'accumulateurs (nickel cadmium) ne doivent pas être mélangés. Des piles neuves et usagées ou des accumulateurs neufs et usagés ne doivent pas être mélangés.
5. Ne pas mélanger des piles alcalines, des piles standard ou d'un type similaire doivent être utilisées.
6. Les piles et les accumulateurs doivent être mis en place en respectant la polarité. (voir le diagramme)
7. Retirer les piles avant rangement du jouet pour une longue période ou bien si les piles sont usées.
8. Les bornes d'une pile ou d'un accumulateur ne doivent pas être mises en court-circuit.

➤ ΠΡΟΣΟΧΗ: ΠΑ ΤΗΝ ΑΠΟΦΥΓΗ ΔΙΑΡΡΗΣΗΣ ΤΗΣ ΜΠΑΤΑΡΙΑΣ

1. Δείτε το διάγραμμα για να δείτε πως να αφαιρέσετε και να τοποθετήσετε τις μπαταρίες.
2. Δεν πρέπει ποτέ να επαναφορτίσετε τις μη επαναφορτιζόμενες μπαταρίες.
3. Θα πρέπει να αφαιρέσετε τις επαναφορτιζόμενες μπαταρίες από το παιχνίδι πριν τις επαναφορτίσετε και θα πρέπει να φορτίσετε τις επαναφορτιζόμενες μπαταρίες κάτω από την επίβλεψη ενήλικου.
4. Να μην αναμιγνύετε αλκαλικές, κανονικές (άνθρακα -μεμβράνη), ή επαναφορτιζόμενες (μικέλυο καδμίου) μπαταρίες. Να μην τοποθετήσετε κανονικές και μεταφορτιζόμενες μπαταρίες μαζί.
5. Να μην αναμιγνύετε新旧 μπαταρίες, του συνδυασμένου τύπου ή εκφοδιστές.
6. Να πρέπει να εισάγετε τις μπαταρίες σύμφωνα με τη σωστή πολικότητα.
7. Να αφαιρέσετε τις μπαταρίες από το παιχνίδι όταν το αποθηκεύετε για παρατεταμένο χρονικό διάστημα ή εάν έχουν εξαντληθεί οι μπαταρίες.
8. Δεν θα πρέπει να βραχυκυκλώσετε τα τερματικά παροχής.

➤ MISE EN PLACE DES PILES

- Avec un tournevis cruciforme, dévisser la porte du compartiment à piles.
- Soulever et ouvrir la porte du compartiment.
- Insérer les piles de 1.5 volts comme indiqué par les pôles + et -.
- Remettre en place la porte et les vis, sans trop les serrer.

➤ INLEGGEN VAN DE BATTERIJEN

- Gebruik een kruisvoetschroevendraaier om het klepje van het batterijvak los te schroeven.
- Licht het klepje op en verwijder het.
- Steek de batterijen van 1.5 volt in met inachtneming van de juiste polariteit.
- Plaats het paneel en de schroeven terug en draai niet te vast aan.

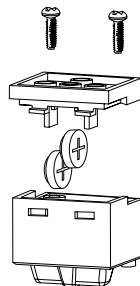

➤ WAARSCHUWING: VOORKOMEN VAN LEKKENDE BATTERIJEN:

1. Wijze waarop vervangbare batterijen moeten worden verwijderd en ingelegd (zie afbeelding).
2. Niet-oplaadbare batterijen mogen niet worden opgeladen.
3. Oplaadbare batterijen dienen vóór het opladen uit het speelgoed te worden verwijderd en alleen onder toezicht van een volwassene te worden opgeladen.
4. Gebruik alkalische, standaard- (zinkloostof) of oplaadbare (nikkelcadmium) batterijen niet tesamen. Gebruik oude en nieuwe batterijen niet tesamen.
5. Uitsluitend batterijen van het aanbevolen type of van een vergelijkbaar type mogen worden gebruikt.
6. Batterijen moeten worden ingelegd met inachtneming van de juiste polariteit (zie afbeelding).
7. Haal de batterijen uit het speelgoed wanneer het voor een lange periode niet gebruikt of als de batterijen leeg zijn.
8. De voedingsklem mag niet worden kortgesloten.

➤ WARNING: UM DAS AUSLAUFEN DER BATTERIEN ZU VERMEIDEN:

1. Einlegen und Auswechseln der Batterien. (Siehe Abbildung)
2. Nichtwiederaufladbare Batterien dürfen nicht wieder aufgeladen werden.
3. Wiederaufladbare Batterien müssen zum Aufladen aus dem Spielzeug herausgenommen werden und dürfen nur unter Aufsicht von Erwachsenen aufgeladen werden.
4. Alte und neue Batterien nicht zusammen verwenden. Alkalibatterien, Standardbatterien (Kohle-Zink-Batterien), wiederaufladbare Batterien (Nickel-Cadmium) nicht mischen. Nur Batterien derselben Sorte verwenden.
5. Nur Batterien der empfohlenen oder ähnlichen Sorte verwenden.
6. Batterien gemäß Polarität einlegen. (siehe Abbildung)
7. Batterien bei längerer Lagerung, oder wenn sie verbraucht sind, aus dem Spielzeug herausnehmen
8. Die Batterieanschlüsse nicht kurzschliessen.

➤ ADVARSEL: SÅDAN UDNÅGS BATTERI-LEKAGE:

1. Se diagrammet om hvordan batterier udtages og indsættes.
2. Ikke opladelige batterier må aldrig oplades.
3. Opladelige batterier skal tages ud af legetøjet før det oplades, og opladelige batterier skal oplades i tilstedeværelse af en voksen.
4. Opladelige (nikkel-kadmium) batterier og alkalisk, standardbatterier (zink-kul) må ikke blandes. Nye og brugte batterier må ikke bruges sammen.
5. Brug kun den foreslåede type batterier eller lignende type.
6. Sæt batterier i med polerne vendt den rigtige vej. (se diagram)
7. Tag batterierne ud, hvis legetøjet ikke skal bruges i længere tid eller hvis batterierne er udrændte.
8. Batteriterminalerne må ikke kortsluttes.

⚠️ VARO: PARISTOJEN VUOTAMISEN ESTÄMINEN:

1. Katso kuvasta, kuinka poistat ja asennat paristot.
2. Ei-ladattavia paristoja ei koskaan saa ladata.
3. Ladattavia paristoja on poistettava leikkikautta ennen niiden lataamista ja lataaminen on tehtävä aikuisen valvonnassa.
4. Älä sekoita alkali-, normaali- (hiili-sinkki) tai ladattavia (nikkelikadmium) -paristoja. Älä sekoita käytettyjä ja uusia paristoja keskenään.
5. Käytä vain suositeltuja tai samankaltaisia paristoja.
6. Paristot on asennettava navat oikein päin. (katso kuva)
7. Poista paristot leikkikalusta, kun leikkikalua säilytetään pitkään aikaa tai jos paristot ovat lopussa.
8. Virtsanapainiin ei saa aiheuttaa oikosulkuja.

⚠️ ATTENZIONE : PER EVITARE PERDITE DALLE PILE

1. Osservare il diagramma per capire come togliere ed inserire le pile
2. Le pile non ricaricabili non devono mai essere ricaricate.
3. Le pile ricaricabili devono essere tolte dal giocattolo prima di essere ricaricate e devono essere ricaricate sotto la supervisione di un adulto.
4. Non mescolare pile alcaline, normali (zinco carbonio) o ricaricabili (nickel cadmium). Non mescolare pile usate e nuove.
5. Si dovrebbero usare solo pile del tipo raccomandato o di un tipo simile.
6. Le pile devono essere inserite secondo la giusta polarità (vedi diagramma).
7. Togliere le pile dal giocattolo prima di lunghi periodi di inutilizzazione o se le pile sono scariche.
8. I terminali di alimentazione non devono essere corto-circuitati.

⚠️ FÖRSIKTIG! SLIK UNNGÅR DU BATTERILEKASKE:

1. Illustrasjonen viser hvordan du skal ta ut og sette inn batteriene.
2. Batterier som ikke er oppladbare, skal aldri lades opp på nytt.
3. Oppladbare batterier må tas ut av leketøyet før de lades opp igjen, og oppladning må skje under oppsyn av en voksen.
4. Alkaliske, standard og oppladbare batterier (nikkelkadmium) skal ikke brukes om hverandre. Nye og gamle batterier skal heller ikke brukes sammen.
5. Bruk kun batterier av anbefalt type eller en tilsvarende type.
6. Batteriene skal settes inn slik at polene vender riktig vei.
7. Ta batteriene ut av leketøyet ved lengre tids oppbevaring og når de er oppbrukte.
8. De elektriske polene må ikke kortsluttes.

⚠️ 注意：電気洩れを防ぐために：

電池の取外し及び挿入については、ダイアグラムをご覧ください。
非再充電式電池へ充電しないで下さい。

再充電を行なう場合には再充電式電池をおもちゃから取り外し、再充電式電池の取扱いは大人が行なって下さい。
アルカリ、標準(炭素-亜鉛)、あるいは再充電式(ニッケルカドミウム)を混合しないで下さい。古い電池と新しい電池を混合して使用しないで下さい。

推奨タイプ、もしくは同等タイプの電池のみを使用して下さい。

電池は正しい電極に挿入して下さい(ダイアグラムを参照下さい)。

おもちゃを長時間使用しない時には、電池を取り外しておいて下さい。そのままにしておくと電池が消耗します。
供給ターミナルは短絡してないこと。

⚠️ 警告：避免電池滲漏。

參看附圖，了解如何裝卸電池。

非充電電池不能充電。

充電之前必須先將充電電池從玩具中取出，充電過程必須由成人監督。

不要將鹼性電池、標準電池(碳化鋅電池)或充電電池(保鎘電池)混在一起使用。不要把新舊電池混在一起使用。

只應當使用我們推薦的電池或者類似型號的電池。

電池必須按正確的極性裝入玩具內。(見附圖)

如果一段時間不用玩具，請取出玩具內的電池，否則電池會消耗干。

電源的正極不能短路。

Non-rechargeable batteries included.

Incluye pilas no recargables.

Piles fournies non-rechargeables.

Niet-oplaadbare batterijen meegeleverd.



2x

1.5V

This toy uses 2 alkaline button cell batteries (SR41, 392, 1134SO or equivalent)

Este juguete utiliza 2 pilas alcalinas de célula de botón (SR41, 392, 1134SO o equivalente)

Ce jouet nécessite 2 piles boutons alcalines (SR41, 392, 1134SO ou l'équivalent)

Dit speelgoed gebruikt 2 alkaline knoopcelbatterijen (SR41, 392, 1134SO of gelijkwaardig)

⚠️ ATENÇÃO:PARA EVITAR O ESCORRIMENTO DAS BATERIAS:

1. Consulte o diagrama sobre a inserção das baterias.
2. As baterias não recarregáveis nunca devem ser recarregadas.
3. As baterias recarregáveis devem ser removidas do brinquedo antes de serem recarregadas. O recarregamento de baterias sempre deve ser supervisionado por um adulto.
4. Não misture baterias alcalinas normais (zinco de carbono) com recarregáveis (níquel cádmio). Não combine baterias novas com usadas.
5. Utilize só baterias do tipo recomendado ou semelhantes.
6. As baterias devem ser inseridas de acordo com a polaridade indicada. (veja o diagrama)
7. Remova as baterias do brinquedo ao armazená-lo por um período prolongado ou se as baterias estiverem gastas.
8. Os terminais de alimentação não devem ser ligados em curto circuito.

⚠️ VAR FÖRSIKTIG! UNDVIK BATTERILEKAGAGE:

1. I diagrammet visas hur batterierna ska bytas ut.
2. Ladda aldrig batterier som inte är avsedda för att återladdas.
3. Laddningsbara batterier måste avladdas från leksaken innan de laddas och laddningsbara batterier måste laddas under övervakning av vuxen.
4. Blanda inte alkaliska, standard (kolzinck) och laddningsbara (nikkelkadmium) batterier. Blanda inte ihop använda och nya batterier.
5. Endast batterier av rekommenderad typ eller liknande bör användas.
6. Batterier måste föras in med polerna i rätt läge. (se diagrammet)
7. Avladdna batterierna från leksaken när den ska förvaras under längre tid eller om batterierna är utsladdade.
8. Strömtilförselterminalerna måste kortslutas.

CAUTION: Batteries are to be changed by an adult. Do not leave batteries within reach of children.
ADVERTENCIA: Las pilas debe cambiarlas un adulto. No dejar las pilas al alcance de los niños.
ATTENTION : Le changement de piles doit être réalisé par un adulte. Ne pas laisser les piles à la portée des enfants.
OPGEPAST: De batterijen moeten door een volwassene worden vervangen.

EN CAUTION:

- Do not leave this toy close to a source of heat or in direct sunlight.
- Do not operate this toy outdoors.
- Operate this toy in a dry area.
- Avoid sand and water. If moisture gets inside the electronic compartment, remove the batteries and allow it to dry thoroughly before using.

ES ADVERTENCIA:

- No exponer este juguete a una fuente de calor ni a los rayos directos del sol.
- No utilizar este juguete en el exterior.
- Utilizar este juguete en un lugar seco.
- Evitar el contacto con agua o arena. Si la humedad penetra en el compartimento eléctrico, retirar las pilas y dejar secar completamente antes de volver a utilizar el juguete.

FR AVERTISSEMENT:

- Ne pas laisser ce jouet près d'une source de chaleur ou directement au soleil.
- Ne pas utiliser ce jouet dehors.
- Utiliser ce jouet dans un endroit sec.
- Ne pas utiliser dans l'eau ni dans le sable. Si l'humidité pénètre dans le compartiment électronique, enlever les piles et laisser sécher complètement avant d'utiliser à nouveau.

NL WAARSCHUWING:

- Stel het speelgoed niet bloot aan een hittebron of aan direct zonlicht.
- Gebruik het speelgoed niet buitenshuis.
- Gebruik het speelgoed op een droge plek.
- Vermijd zand en water. Mocht er toch vocht in het elektronicavak terechtkomen, verwijder de batterijen dan en laat het speelgoed grondig drogen voordat het weer wordt gebruikt.

TROUBLE SHOOTER GUIDE / PROBLEMAS Y SOLUCIONES / PROBLÈMES ET SOLUTIONS / FEHLERBEHEBUNG

Problem	Possible cause	Try this solution
<ul style="list-style-type: none"> • Weak and distorted sound. • No power 	<ul style="list-style-type: none"> • Weak batteries • Dead batteries • Incorrect Battery placement. • Dirty battery contacts 	<ul style="list-style-type: none"> • Replace batteries • Remove batteries and install according to instructions and diagram.

Problema	Causas posibles	Intente lo siguiente
<ul style="list-style-type: none"> • Sonido distorsionado y débil • No emite sonidos. 	<ul style="list-style-type: none"> • Las pilas están débiles. • Las pilas están gastadas. • Las pilas han sido colocadas incorrectamente. • Los bornes están sucios. 	<ul style="list-style-type: none"> • Cambie las pilas. • Retire las pilas y vuelva a colocarlas, siguiendo las instrucciones y diagramas.

Problème	Causes possibles	Essayez cette solution
<ul style="list-style-type: none"> • Son faible et déformé • Il n'y a aucun son. 	<ul style="list-style-type: none"> • Piles faibles. • Piles usées. • Piles mal installées. • Contacts encrassés. 	<ul style="list-style-type: none"> • Remplacer les piles. • Enlever les piles et les remettre en place selon les instructions et diagrammes

Problem	Mögliche Lösung	Mögliche Lösung
<ul style="list-style-type: none"> • Geräusch schwach oder verzerrt. • Spielzeug funktioniert nicht. 	<ul style="list-style-type: none"> • Batterien sind schwach. • Batterien sind leer. • Batterien wurden falsch eingesetzt. • Batteriekontakte sind schmutzig. 	<ul style="list-style-type: none"> • Batterien austauschen. • Batterien herausnehmen und laut Anweisung und Diagramm neu einlegen.

IF YOU HAVE A PROBLEM, PLEASE DO NOT TAKE THIS TOY BACK TO THE STORE. CONTACT US
EN CASO DE PROBLEMAS, NO DEVUELVA EL PRODUCTO A LA TIENDA DONDE LO COMPRÓ. CONTÁCTENOS
VOUS AVEZ DES PROBLÈMES? ON VOUS PRIERAIT DE NE PAS RETOURNER CE JOUET AU MAGASIN. CONTACTEZ-NOUS
HEEFT U PROBLEEM? BRENG HET SPEELGOED DAN NIET TERUG NAAR DE WINKEL. NEEM CONTACT MET ONS OP

1-800-465-MEGA

U.S. & Canada only / Solamente en EEUU y Canadá
É.U. et Canada seulement / Uitsluitend in de V.S. en Canada
WWW.MEGABLOKS.COM

- EN** ⚠ **WARNING :**
CHOKING HAZARD. - Small parts.
Not for children under 3 years.
- ES** ⚠ **ADVERTENCIA :**
PELIGRO DE ASFIXIA. - Contiene piezas pequeñas.
No recomendado para niños menores de 3 años.
- FR** ⚠ **AVERTISSEMENT :**
RISQUE DE SUFFOCATION. - Présence de petits éléments.
Ne convient pas aux enfants de moins de 3 ans.
- NL** ⚠ **WAARSCHUWING:**
VERSTIKKINGSGEVAAR. - Bevat kleine onderdelen.
Niet geschikt voor kinderen onder de 3 jaar.
- DE** ⚠ **WARNUNG:**
ERSTICKUNGSGEFAHR. - Enthält kleine Teile.
Nicht für Kinder unter 3 Jahren geeignet.
- DA** ⚠ **ADVARSEL:**
KVÆLNINGSFARE. - Indeholder smådele.
Ikke til børn under 3 år.
- EL** ⚠ **ΠΡΟΕΙΔΟΠΟΙΗΣΗ:**
ΚΙΝΔΥΝΟΣ ΠΝΙΞΙΜΑΤΟΣ. - Περιέχει μικρά αντικείμενα.
Όχι για παιδιά κάτω των 3 ετών.
- FI** ⚠ **VAROITUS:**
TUKENTUMISVAARA. - Sisältää pieniä osia.
Ei alle 3-vuotiaille lapsille.
- IT** ⚠ **ATTENZIONE:**
PERICOLO DI SOFFOCAMENTO. - Contiene piccole parti.
Non indicato per bambini sotto i 3 anni.
- NO** ⚠ **ADVARSEL:**
KVELNINGSFARE. - Inneholder små deler.
Kun for barn over 3 år.

- PT** ⚠ **ATENÇÃO:**
PERIGO DE ASFIXIA. - Contém peças pequenas.
Não é concebido para crianças de menos de 3 anos.
- SV** ⚠ **WARNING!**
KVÄVNINGSRISK. - Innehåller små delar.
Inte för barn under 3 år.
- JA** ⚠ **警告:**
窒息の危険性 小さな部品が含まれています
3歳以下の子供には与えないで下さい。
- ZH** ⚠ **警告:**
有窒息危險。包含有小部件
不适合3岁以下的小孩玩。

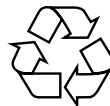

LIFETIME GUARANTEE*
GARANTIZADO DE POR VIDA*
GARANTIE À VIE*
LEVENSLANGE GARANTIE*

COMMENTS, QUESTIONS ? / ¿ COMENTARIOS, PREGUNTAS ?
COMMENTAIRES, QUESTIONS ? / COMMENTAAR, VRAGEN ?

1-800-465-MEGA
U.S. & Canada only / Solamente en EEUU y Canadá
É.U. et Canada seulement / Uitsluitend in de V.S. en Canada
www.megabloks.com

- *Guarantee on blocks only.
*La garantía se aplica únicamente a los bloques.
*Garantie applicable sur les blocs seulement.
*Garantie geldt uitsluitend voor blokken.

5951 Military Chopper



Nano Sized™

**MEGA
BLOKS**

© 2004, MEGA BLOKS INC.
© and™ denote trademarks of MEGA BLOKS INC.
© y™ designan la marca registrada y la marca comercial de MEGA BLOKS INC.
© el™ désignent des marques de commerce de MEGA BLOKS INC.
© en™ duiden op handelsmerken van MEGA BLOKS INC.

PRINTED IN CHINA A0059512